

# Portland 1Dr Wall 900

## CABINET SPECIFICATION



Product Features	
Product Code	2973-W
Product Description	Portland - Wall 900
Drawer Configuration	1 Drawer
Basin	Loop 900, Ceramic
Overflow Configuration	Overflow provided Max tap flow rate of 15 litres / minute
Notes	Drawings depict cabinet only

INDICATES FLOOR SURFACE -----

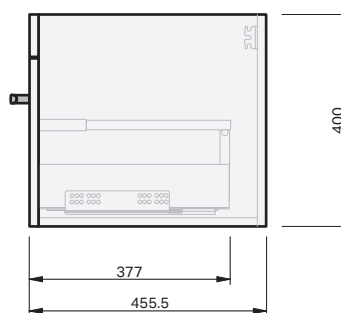
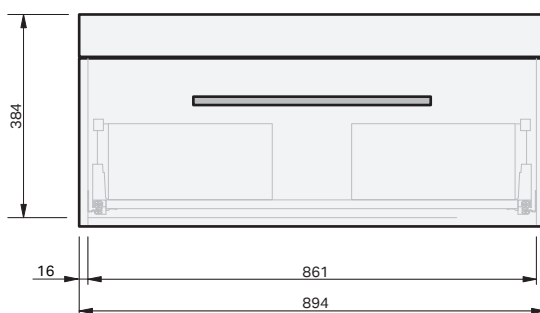
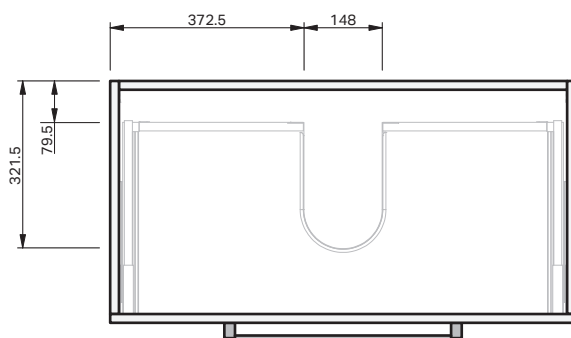

**IMPORTANT NOTE:** Throughout this guide, dimensions may vary by  $\pm 2$ mm. Please read the installation manual for detailed information on installing the product. St. Michel pursues a policy of continuing improvement in design and manufacturing of its products. The right is therefore reserved to vary specifications without notice.

**st.michel**  
BATHROOMWARE

phone (09) 837 4276 email [info@stmichel.co.nz](mailto:info@stmichel.co.nz) [stmichel.co.nz](http://stmichel.co.nz)

# Portland 2Dr Wall 900

## CABINET SPECIFICATION



Product Features	
Product Code	2974-W
Product Description	Portland - Wall 900
Drawer Configuration	2 Drawer
Basin	Loop 900, Ceramic
Overflow Configuration	Overflow provided Max tap flow rate of 15 litres / minute
Notes	Drawings depict cabinet only

INDICATES FLOOR SURFACE -----

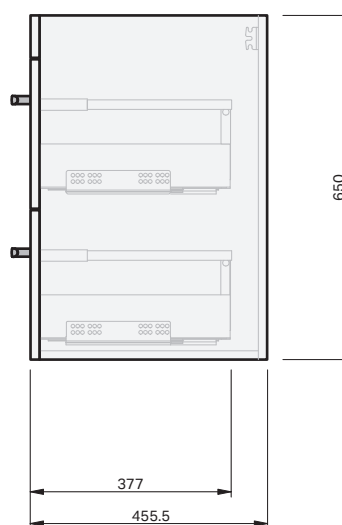
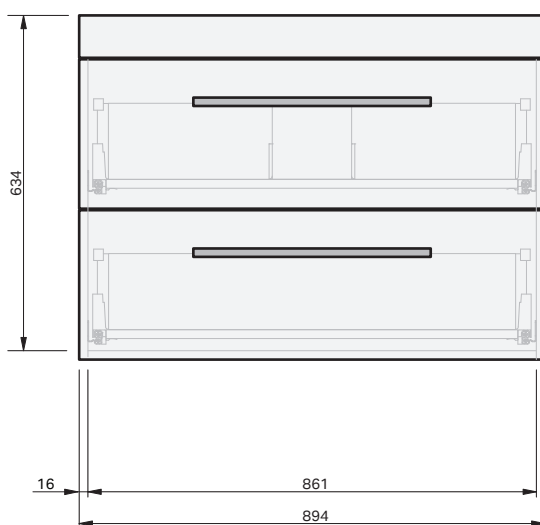
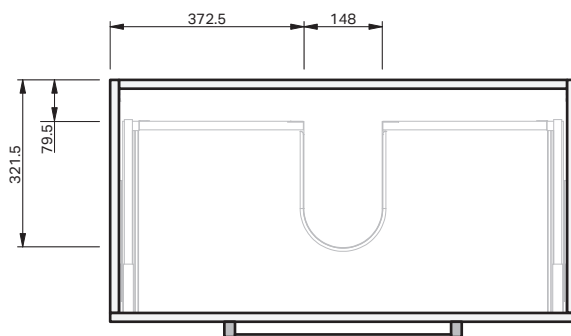

**IMPORTANT NOTE:** Throughout this guide, dimensions may vary by  $\pm 2$ mm. Please read the installation manual for detailed information on installing the product. St. Michel pursues a policy of continuing improvement in design and manufacturing of its products. The right is therefore reserved to vary specifications without notice.

**st.michel**  
BATHROOMWARE

phone (09) 837 4276 email [info@stmichel.co.nz](mailto:info@stmichel.co.nz) [stmichel.co.nz](http://stmichel.co.nz)

# Portland 2Dr Floor 900

## CABINET SPECIFICATION



### Product Features

Product Code	2975-W
Product Description	Portland - Floor 900
Drawer Configuration	2 Drawer
Basin	Loop 900, Ceramic
Overflow Configuration	Overflow provided Max tap flow rate of 15 litres / minute
Notes	Drawings depict cabinet only

INDICATES FLOOR SURFACE -----

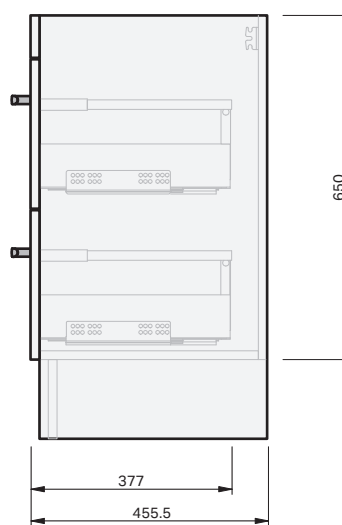
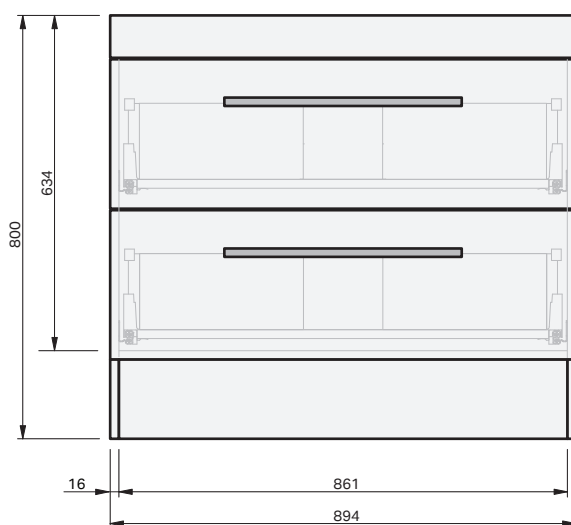
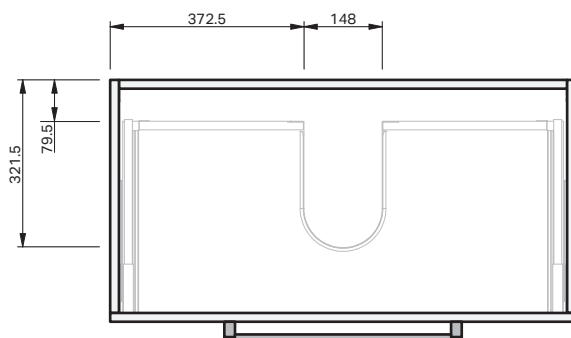

**IMPORTANT NOTE:** Throughout this guide, dimensions may vary by  $\pm 2$ mm. Please read the installation manual for detailed information on installing the product. St. Michel pursues a policy of continuing improvement in design and manufacturing of its products. The right is therefore reserved to vary specifications without notice.



phone (09) 837 4276 email [info@stmichel.co.nz](mailto:info@stmichel.co.nz) [stmichel.co.nz](http://stmichel.co.nz)

# Loop 900

## BASIN SPECIFICATION



### Product Features

Product Code	26801
Type of basin	Console
Material of basin	Ceramic
Capacity of basin	6.5 litre
Overflow Configuration	Overflow provided Max tap flow rate of 15 litres / minute
Colour options	White Gloss

INDICATES TOP SURFACE -----

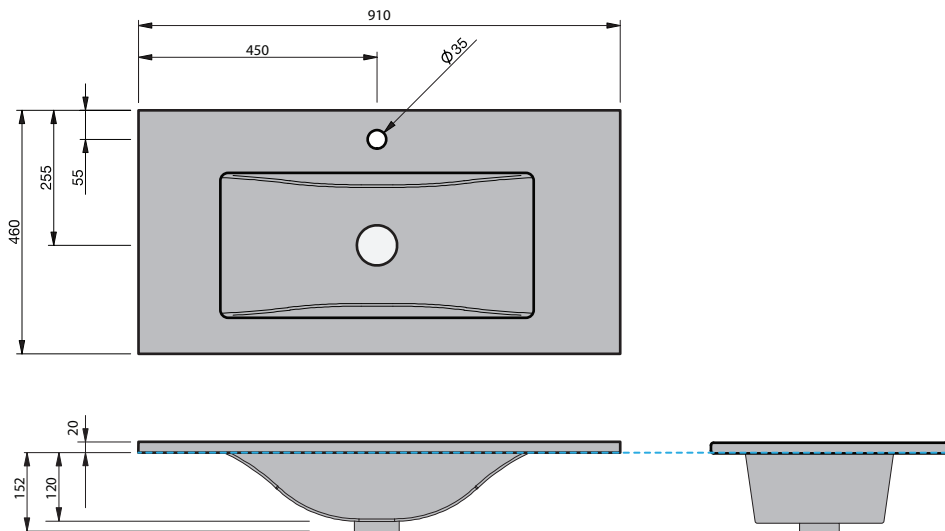

**IMPORTANT NOTE:** Throughout this guide, dimensions may vary by  $\pm 2$ mm. Please read the installation manual for detailed information on installing the product. St. Michel pursues a policy of continuing improvement in design and manufacturing of its products. The right is therefore reserved to vary specifications without notice.

st.michel  
BATHROOMWARE

phone (09) 837 4276 email [info@stmichel.co.nz](mailto:info@stmichel.co.nz) [stmichel.co.nz](http://stmichel.co.nz)