

Flo 50 Console

1200DB Wall 1 Drawer

exclusive to
plumbingworld

CABINET SPECIFICATION



Product Features

Product Code	Console Vanity / 9822
Product Description	Flo - Wall - 1200DB
Cabinet Material*	Durashell®
Drawer Configuration	1 Drawer

Notes: Drawings depict cabinet only.
Vanity includes Onda Storage system Type A or Type B, refer charts.

*Both the cabinet front and sides are made of Durashell®, except for Baroque Woodgrain and Classic White Satin, which feature Durashell® fronts and matching Melamine sides (with Aqua Edge®).

Cabinet Finishes Available



- Flo F2 Finish** 1. Classic White Satin,
Flo F3 Finish 2. Black Satin, 3. Lana Grey Satin, 4. Slate Matte,
5. Pistachio Matte, 6. Villa Blue Matte, 7. Baroque Woodgrain

Handle Colours Available



- Soul Handle** 1. Matte Black, 2. Brushed Brass, 3. Brushed Nickel, 4. Gunmetal,
5. Chrome, 6. Matte White, 7. Brushed Copper.

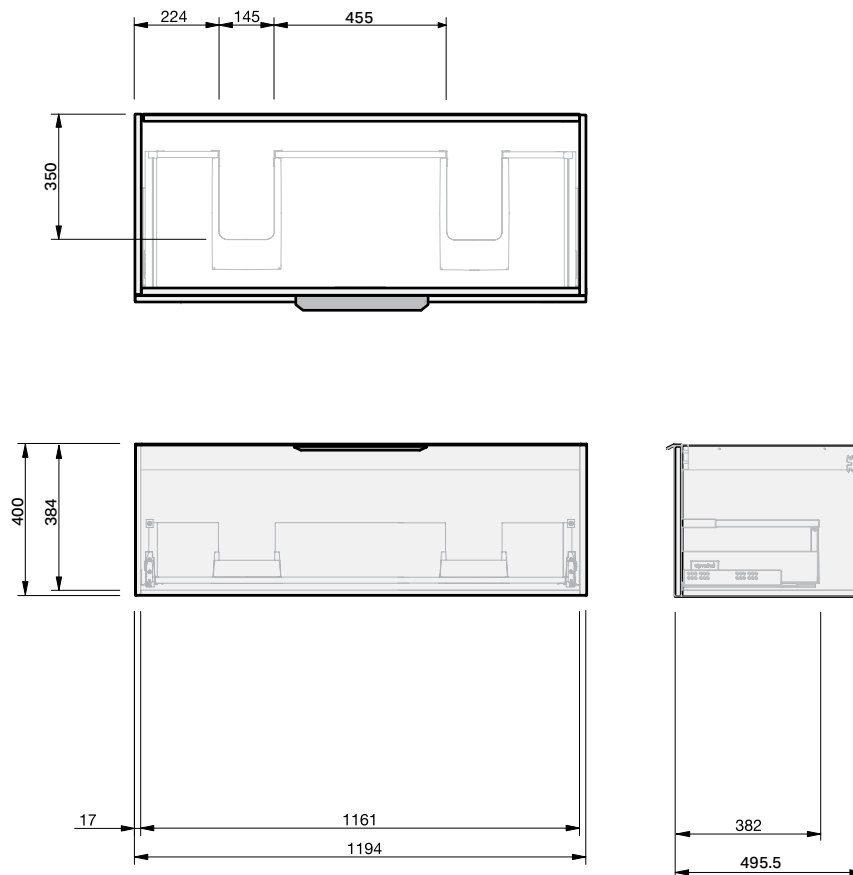

IMPORTANT NOTE: Throughout this guide, dimensions may vary by ± 2 mm. Please read the installation manual for detailed information on installing the product. St. Michel pursues a policy of continuing improvement in design and manufacturing of its products. The right is therefore reserved to vary specifications without notice.

st.michel
BATHROOMWARE

phone (09) 837 4276 email info@stmichel.co.nz stmichel.co.nz

Lauretta 1200 DB

BASIN SPECIFICATION

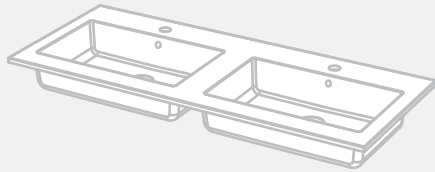

Product Features

Product Code	2167
Type of basin	Console
Material of basin	Mineral Cast
Capacity of basin	8.5 litre
Overflow Configuration	Overflow supplied Max tap flow rate of 15 ltrs / minute
Colour options	White Gloss

- The basin must be sealed to the top with an acetic cured silicone sealant.
- Epoxy type sealants must not be used.

Cabinet range (refer to applicable cabinet specifications)



SAVOY 50



INDICATES TOP SURFACE -----

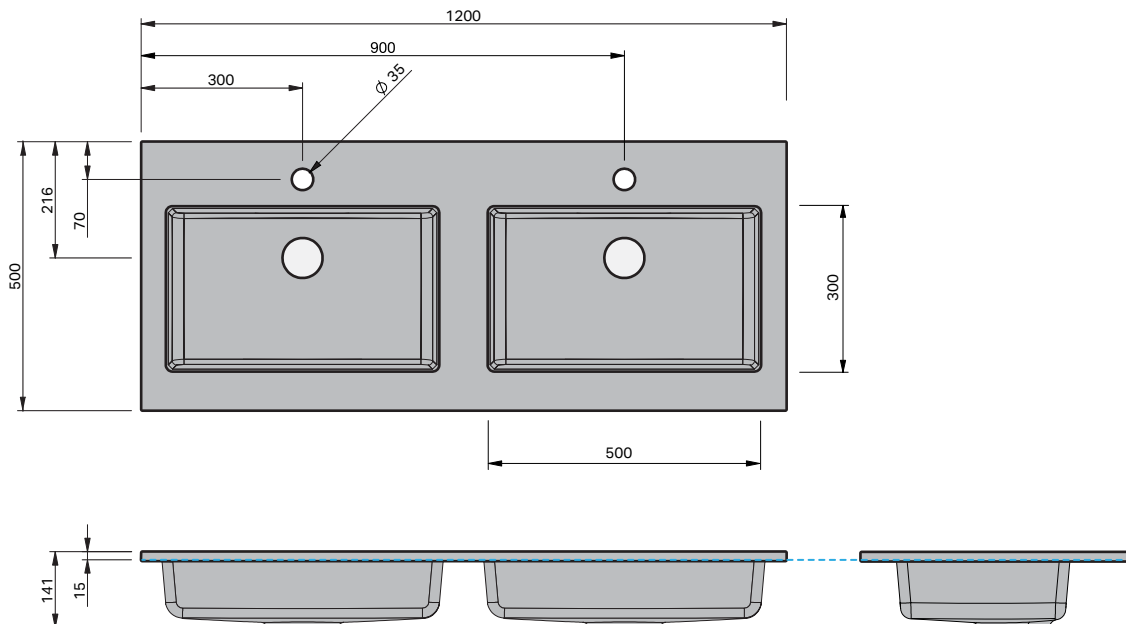

IMPORTANT NOTE: Throughout this guide, dimensions may vary by ± 2 mm. Please read the installation manual for detailed information on installing the product. St. Michel pursues a policy of continuing improvement in design and manufacturing of its products. The right is therefore reserved to vary specifications without notice.

st.michel
BATHROOMWARE

phone (09) 837 4276 email info@stmichel.co.nz stmichel.co.nz