

Flo 22 Benchtop 800 Wall 1 Door

exclusive to
plumbingworld

CABINET SPECIFICATION

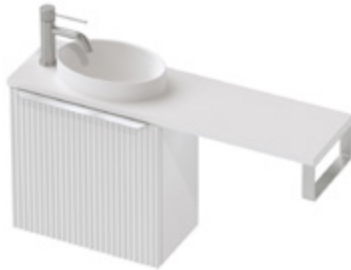

Product Features

Product Code	9807BT
Product Description	Flo 22 Benchtop - 800 Wall
Cabinet Material*	Durashell®
Drawer Configuration	1 Door
Notes	Drawing depicts cabinet only

*Both the cabinet front and sides are made of Durashell®, except for Baroque Woodgrain and Classic White Satin, which feature Durashell® fronts and matching Melamine sides (with Aqua Edge®).

Cabinet Finishes Available



- Flo F2 Finish** 1. Classic White Satin,
Flo F3 Finish 2. Black Satin, 3. Lana Grey Satin, 4. Slate Matte,
 5. Pistachio Matte, 6. Villa Blue Matte, 7. Baroque Woodgrain

Handle Colours Available



- Soul Handle** 1. Matte Black, 2. Brushed Brass, 3. Brushed Nickel, 4. Gunmetal,
 5. Chrome, 6. Matte White, 7. Brushed Copper.

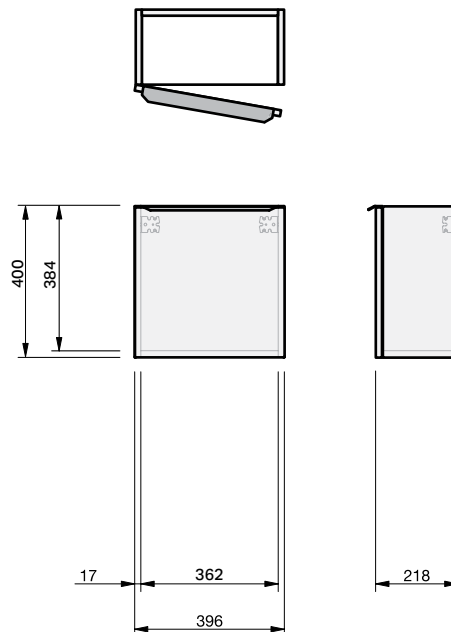

IMPORTANT NOTE: Throughout this guide, dimensions may vary by ± 2 mm. Please read the installation manual for detailed information on installing the product. St. Michel pursues a policy of continuing improvement in design and manufacturing of its products. The right is therefore reserved to vary specifications without notice.

st.michel
BATHROOMWARE

phone (09) 837 4276 email info@stmichel.co.nz stmichel.co.nz

Flo 22 Benchtop

TOP SPECIFICATION

Top Thickness (mm) [Ⓕ]

Cabinet	Cherry Pie	HPL				
Flo 22 Benchtop	20.5	17.5				

Product Dimensions (mm)

	Ⓐ	Ⓑ	Ⓒ	Ⓓ	Ⓔ
Flo 22 Benchtop - 400	400	224	-	-	-
Flo 22 Benchtop - 550	550	224	-	-	-
Flo 22 Benchtop - 800	800	224	-	-	-

- The top must be sealed to the vanity unit with an acetic cured silicone sealant. Epoxy type sealants must not be used
- Tops can be drilled on site with a standard hole saw

Benchtop Finishes Available



HPL Woodgrain (BT1)

1. Baroque, 2. Hamptons Elm, 3. Sovereign Oak, 4. Premium Oak - all with Aqua Edge®

HPL Soft-Matte (BT2)

5. Black Soft-Matte, 6. Devious Soft-Matte, 7. Foxy Soft-Matte, 8. Minx Soft-Matte, 9. Wicked Soft-Matte - all with Aqua Edge®

HPL Smooth (BT2)

10. White Concrete Smooth - with Aqua Edge®

Cherry Pie® Solid Surface (BT3)

11. Bright White, 12. Sugar Cream, 13. Carrara, 14. Calacatta 15. Alabaster, 16. Grey Travertine.

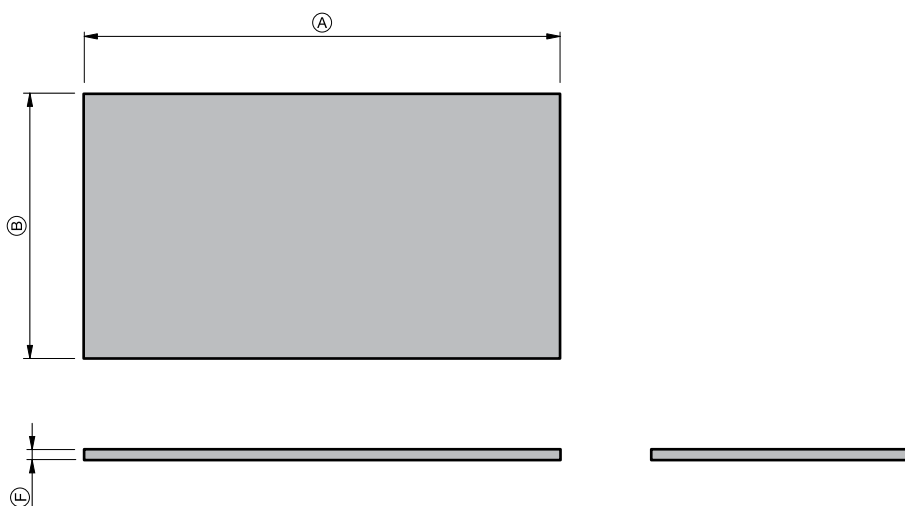

IMPORTANT NOTE: Throughout this guide, dimensions may vary by ± 2 mm. Please read the installation manual for detailed information on installing the product. St. Michel pursues a policy of continuing improvement in design and manufacturing of its products. The right is therefore reserved to vary specifications without notice.

st.michel
BATHROOMWARE

phone (09) 837 4276 email info@stmichel.co.nz stmichel.co.nz

BASIN SPECIFICATION



Product Features

Product Code	Gloss White Mineral Cast / 2101 Matte White Solid Surface / 2100
Type of basin	Inset
Material of basin	Mineral Cast Solid Surface
Capacity of basin	2.5 litre
Overflow Configuration	No overflow

Notes:

- This basin is reversible.
- The basin must be sealed to the top with an acetic cured silicone sealant.
- Epoxy type sealants must not be used.

INDICATES TOP SURFACE -----

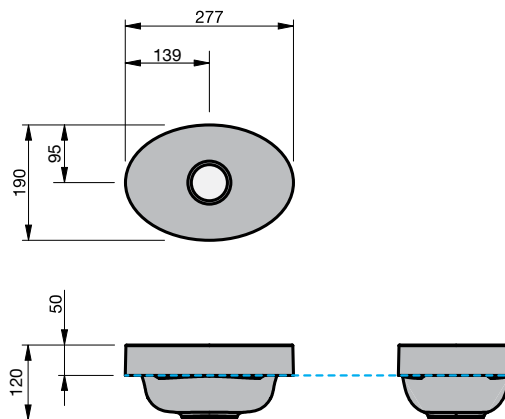

IMPORTANT NOTE: Throughout this guide, dimensions may vary by ± 2 mm. Please read the installation manual for detailed information on installing the product. St. Michel pursues a policy of continuing improvement in design and manufacturing of its products. The right is therefore reserved to vary specifications without notice.