

Corrine 750

BASIN SPECIFICATION



Product Features

Product Code	2181
Type of basin	Console
Material of basin	Mineral Cast
Capacity of basin	9 litre
Overflow Configuration	Overflow not supplied
Colour options	White Gloss



- Can not be wall hung.
- The basin must be sealed to the top with an acetic cured silicone sealant.
- Epoxy type sealants must not be used.

Cabinet range (refer to applicable cabinet specifications)



CASA

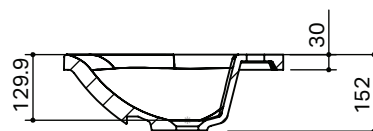
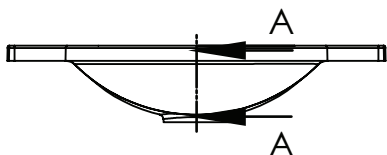
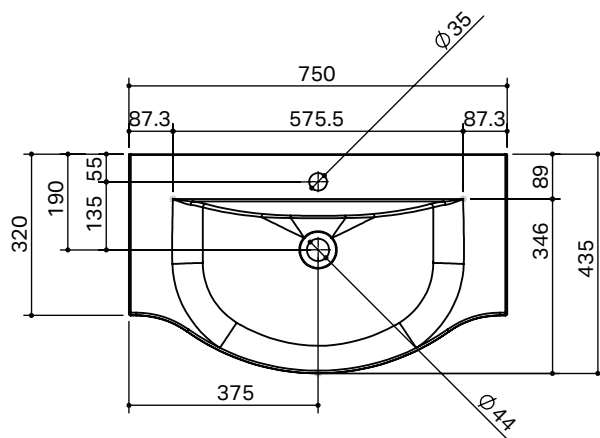

SECTION A-A

IMPORTANT NOTE: Throughout this guide, dimensions are nominal. Please read the installation manual for detailed information on installing the product. St. Michel pursues a policy of continuing improvement in design and manufacturing of its products. The right is therefore reserved to vary specifications without notice.

st.michel
BATHROOMWARE

phone (09) 837 4276 email info@stmichel.co.nz stmichel.co.nz