

smartB 7401

BASIN SPECIFICATION



Product Features

Product Code	Gloss White / 11413 Matte Black / 11414
Type of basin	Vessel
Material of basin	Ceramic
Capacity of basin	7.5 litre
Overflow Configuration	No overflow
Colour Options	Gloss White Matte Black

- The basin must be sealed to the top with an acetic cured silicone sealant.
- Epoxy type sealants must not be used.

INDICATES FURNITURE TOP SURFACE -----

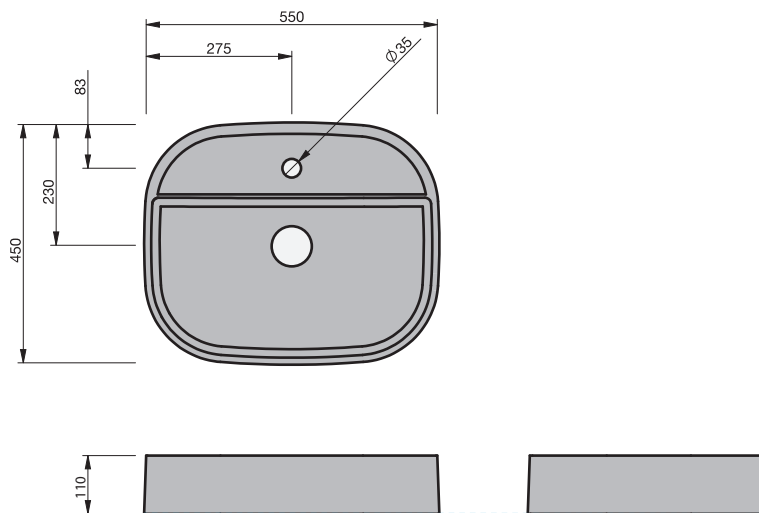

IMPORTANT NOTE: Throughout this guide, dimensions may vary by ± 5 mm. Please read the installation manual for detailed information on installing the product. St. Michel pursues a policy of continuing improvement in design and manufacturing of its products. The right is therefore reserved to vary specifications without notice.

st.michel
BATHROOMWARE

phone (09) 837 4276 email info@stmichel.co.nz stmichel.co.nz