

MIRROR CABINET INSTALLATION INSTRUCTIONS

PLEASE READ CAREFULLY

Dear Customer,

Congratulations on buying a St Michel Mirror Cabinet!!

To ensure total satisfaction with your Mirror Cabinet it is important the cabinet is installed correctly and the conditions of use are noted. This mirror cabinet carries a full warranty against faulty workmanship and material. Please inspect thoroughly before installation to ensure this unit has not been damaged in transit as the warranty does not cover the cost of removal and installation once installed.

It is important that your bathroom is adequately ventilated to eliminate moisture build up. High humidity will lead to permanent dampness and mould resulting in a deterioration of the materials in your bathroom.

INSTALLATION:

When positioning the mirror cabinet, consider the following recommendations:

- Place the cabinet on a flat surface with the doors facing upwards.
- Open each door individually and by applying light finger pressure to the clip at the rear of the hinge, press the clip forward, this will release the hinge and door away from the cabinet. Repeat twice to remove door completely from the cabinet.
- Ensure the door is held firmly at 90 degrees while removing from the cabinet.
- Position the cabinet on the wall at the desired height, ensure the cabinet is level and mark the four corners on the wall.
- Ensure your fixings (screws supplied) will be into studs or nogs on each side of the cabinet as close to the top and bottom corners as possible. If this is not possible then use the raw plugs supplied.
- Liaise with your local hardware supplier for alternate wall fixing systems should your walls not be Gib.
- When you have secured the cabinet to the wall ensure it is level.
- If the mirror cabinet has been supplied with glass shelves it is at this point you place them in the cabinet. Ensure the shelves are fitted correctly into the shelf supports.
- Hold the door up to the cabinet and gently slide the hinge into position. Repeat until all doors are back on the cabinet.
- If the doors require adjustment please read the instructions under Door Alignment.

CLEANING AND MIRROR CARE:

- Cleaners that are acidic or alkali should be avoided in particular those that boast double strength ammonia. (Ammonia is a stripping agent for the protective copper coating and can quickly and severely destroy the mirror.)
- To clean your mirror wipe over with a chamois or soft cloth dipped in warm water and methylated spirits.
- Cleaning fluid should not be applied directly onto the mirror face, as it could spill over the edges onto the back of the mirror.
- Always apply the cleaning solution to a cloth and wipe the mirror, ensuring all edges are thoroughly dry.
- Remove all moisture caused by wet hands, steam or water with a soft cloth after each use.
- Avoid using Abrasive cleaners that will scratch or harm the mirror.
- For the best results, St Michel recommends you use either Hi - Sheen or Universal Glass Cleaner by Glass Corp. (Ph: 09 415 6338)

HINGES:

Clip hinges which require only light finger pressure to clip into place and allow the doors to be easily removed for access to plumb fittings.

DOOR ALIGNMENT:

Your doors have been adjusted in the factory on a level surface to achieve matching height, equal gap and surface alignment. Before you adjust the doors, ensure the vanity has been installed on a level floor or the vanity packed under the base to make it level. When level, if the doors still do not align, adjustment can be made to the hinges as follows:

- A. Side adjustment** - To move the doors sideways in total or to level each door - Turn screw A clockwise or anticlockwise.
- B. Depth adjustment** - To move the door inward or outward from the carcass - Loosen the hinge arm fastening screw B and slide in the direction you want to go. Retighten hinge arm fastening screw B.
- C. Height adjustment** - Loosen the top and bottom screw C on each mount plate, adjust and retighten.

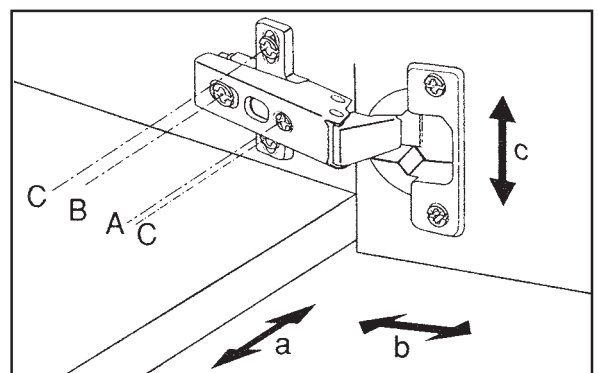

dante plus

600

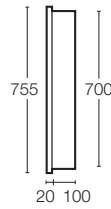
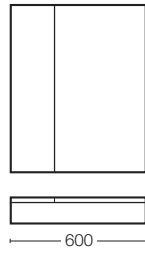

standard



deep

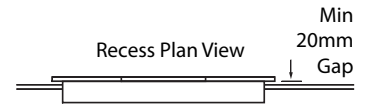

750

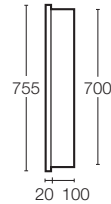
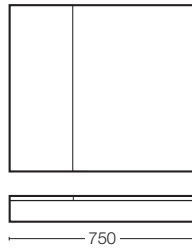

standard



deep

900

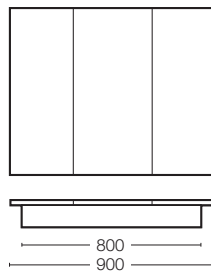

standard



deep

1050

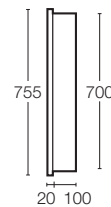
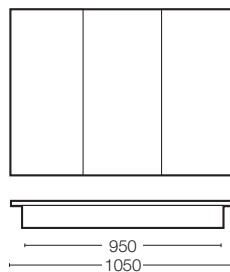

standard



deep

tall

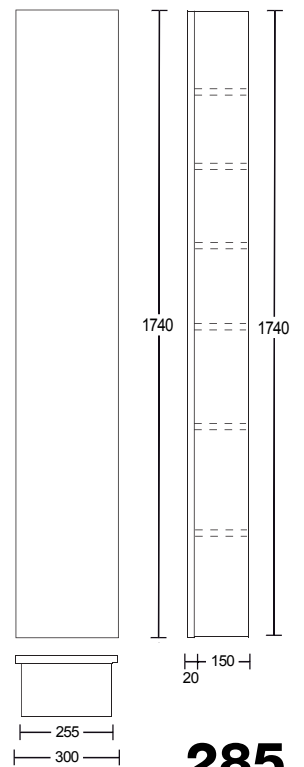

285

1200

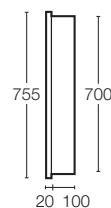
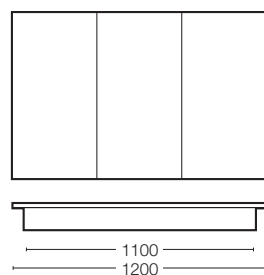

standard

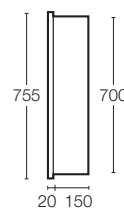

deep

1500

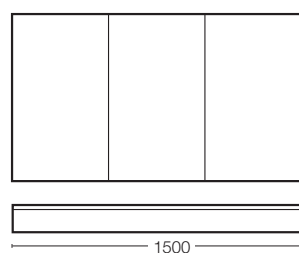

standard

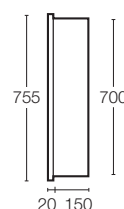

deep

All dimensions are in millimetres nominal. St Michel Industries Ltd has the right to change product and specifications without notice. 2019