

Lauretta 900 RH

BASIN SPECIFICATION

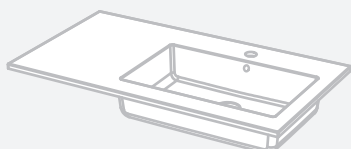

Product Features

Product Code	2163
Type of basin	Console
Material of basin	Mineral Cast
Capacity of basin	8.5 litre
Overflow Configuration	Overflow supplied Max tap flow rate of 15 ltrs / minute
Colour options	White Gloss

- The basin must be sealed to the top with an acetic cured silicone sealant.
- Epoxy type sealants must not be used.

Cabinet range (refer to applicable cabinet specifications)



SAVOY 50



INDICATES TOP SURFACE -----

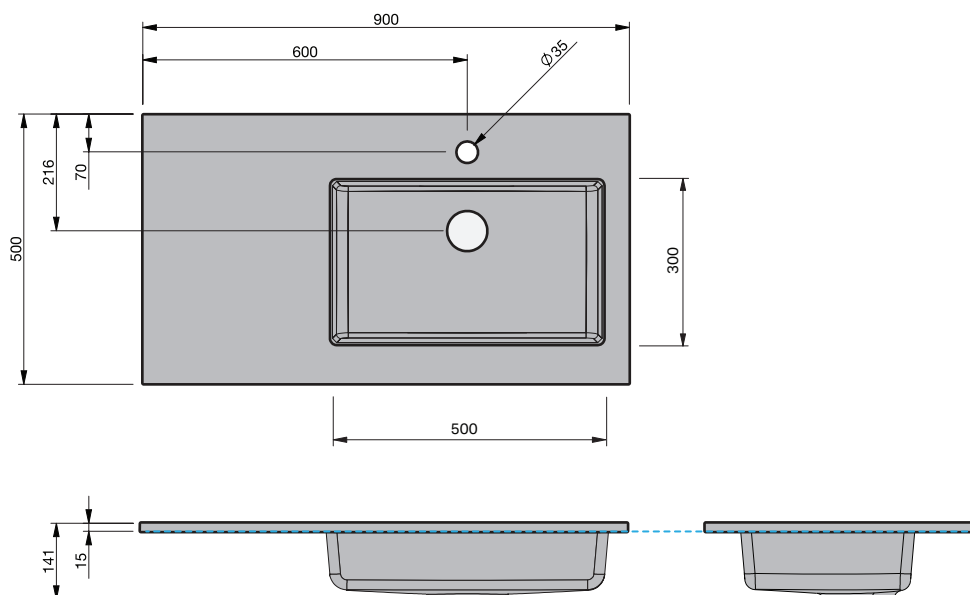

IMPORTANT NOTE: Throughout this guide, dimensions may vary by ± 2 mm. Please read the installation manual for detailed information on installing the product. St. Michel pursues a policy of continuing improvement in design and manufacturing of its products. The right is therefore reserved to vary specifications without notice.

st.michel
BATHROOMWARE

phone (09) 837 4276 email info@stmichel.co.nz stmichel.co.nz