

CABINET SPECIFICATION

City 50 Wall to Wall - 1201-1300 - Wall - 2 drawer, 1 door

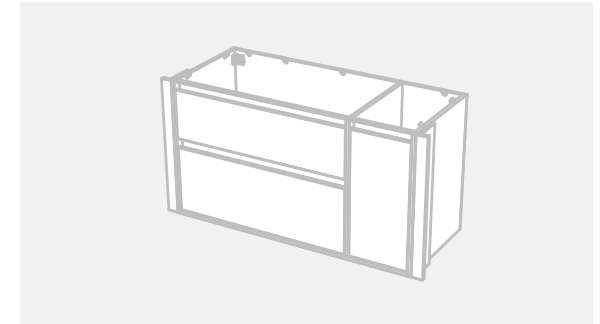

Basin range (refer to applicable basin specification)

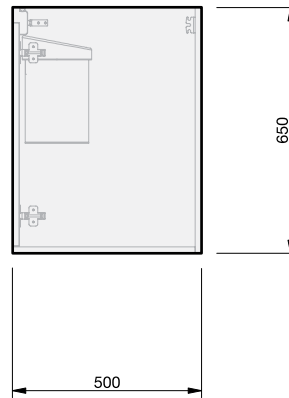
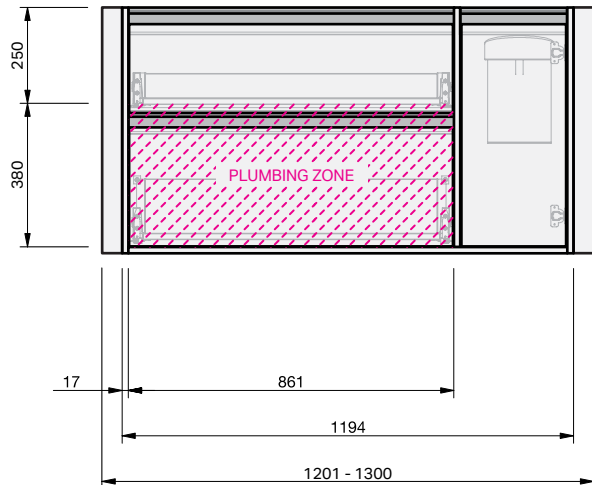
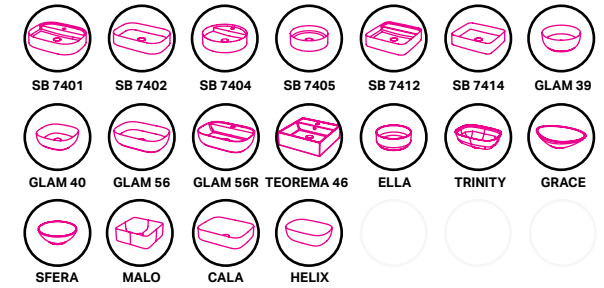

- Drawings depict cabinet only.
- It is important to decide on what height you want your finished top from the floor, this will determine where your plumbing will be positioned.
- We suggest that you install your wall hung vanity between 830-950mm high to the finished top surface.
- Compact trap & waste supplied with vanity.
- Wall to Wall Spacer Kit supplied - see instructions for installation.
- Onda Storage Type B & Brabantia 3L Bin supplied with vanity.



30 YEARS



AQUAEDGE



SOFT CLOSE



ONDA STORAGE

INDICATES PLUMBING - - - - -

INDICATES TOP SURFACE - - - - -

IMPORTANT NOTE: Throughout this guide, dimensions may vary by ± 2 mm. Please read the installation manual for detailed information on installing the product. St. Michel pursues a policy of continuing improvement in design and manufacturing of its products. The right is therefore reserved to vary specifications without notice. For full installation instructions visit stmichel.co.nz.