

HPL Top Fixings & Bench Top Trimming & Fitting Instructions

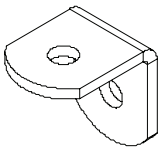

8x



16x

(Note: Only HPL tops require fixings. HPL fixings supplied)

TRIMMING & FITTING TOP - WALL TO WALL SOLUTION

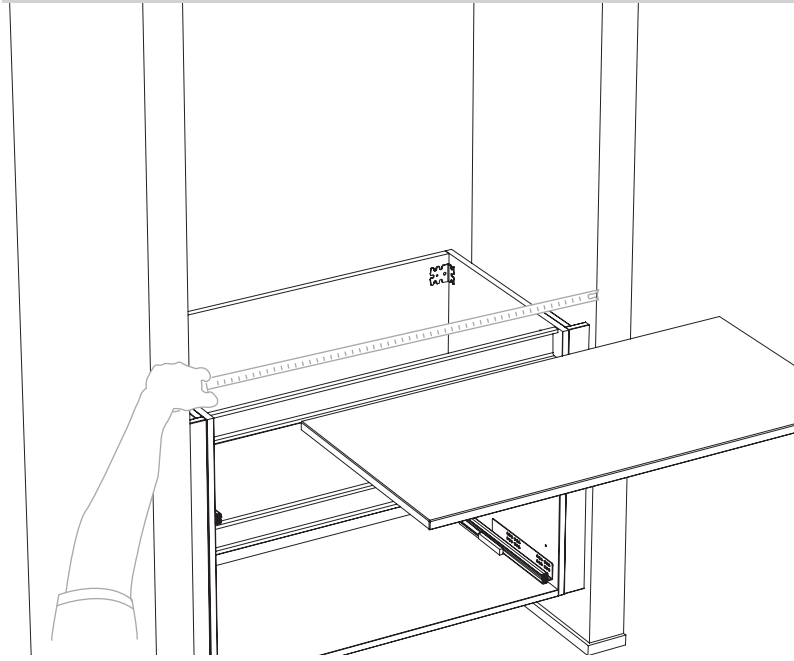

- 1 Measure front & back lengths to determine measurements for the perfect fit.

BENCHTOP TAPHOLE & BASIN WASTE HOLE DRILLING

refer to basin
specification sheet to
determine location

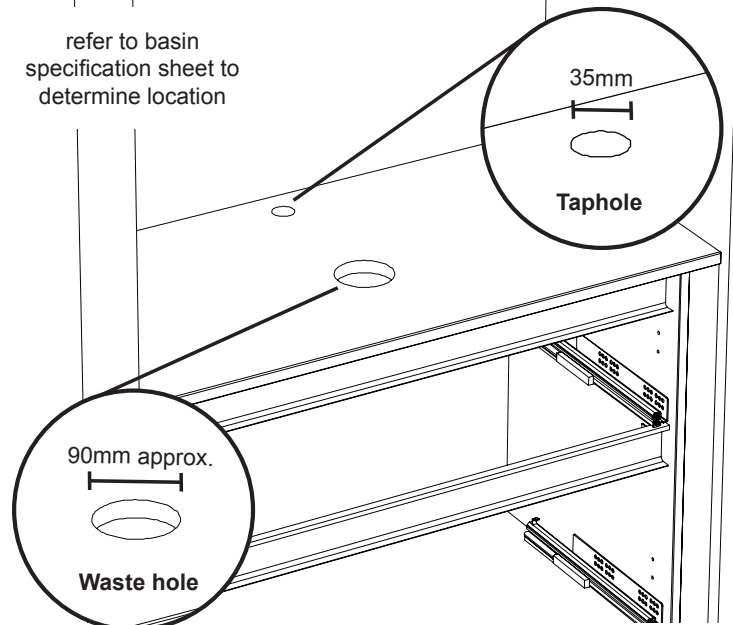

- 2 Trim edges using either a circular saw with tungsten tip blade or electric planer suitable for HPL & Cherry Pie tops. Note: we recommend masking necessary edges and surfaces to protect from chipping & scratching while using cutting tools.

- 3 Decide on the location of your taphole & basin waste hole and measure out position. Drill a pilot hole through the counter top at your center point. This hole should be just slightly smaller than the size of the pilot bit of your hole saw.
Remove top before cutting with holesaw. Use a sharp Bi-Metal Holesaw to prevent damage to your top.
When cutting the required hole size:
 - Standard taphole size = 35mm
 - Standard waste hole for above counter vessel basins = approx. 90mm (this will allow for tolerances when fitting plumbing connections)

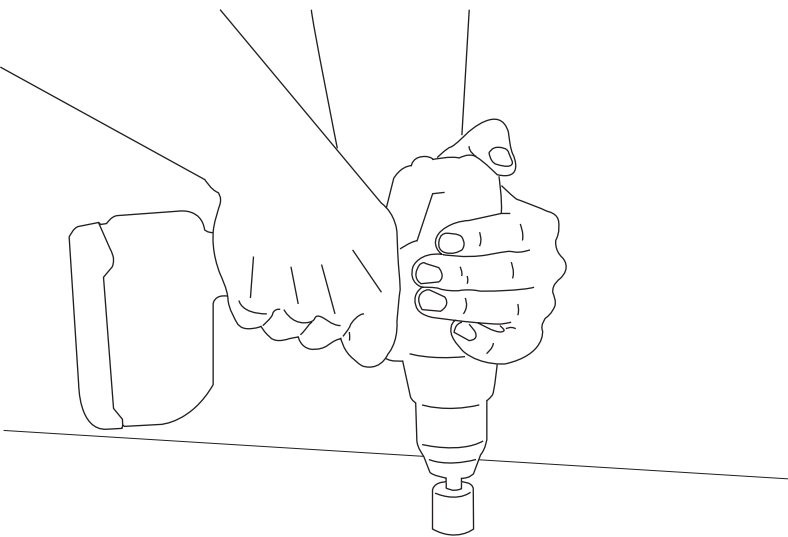

- 4** Firmly clamp top down before drilling (handle with care to ensure no damage occurs to the top during this process)
- Begin with the top side facing up
 - Use the pilot hole as a guide
 - Keep drill speed moderately low, apply enough pressure to keep the hole saw cutting at an even rate.
 - Cut hole into surface approximately half way through
 - Then flip top upside down & finish off cutting the holes from the underside to prevent chipping and breakthrough.

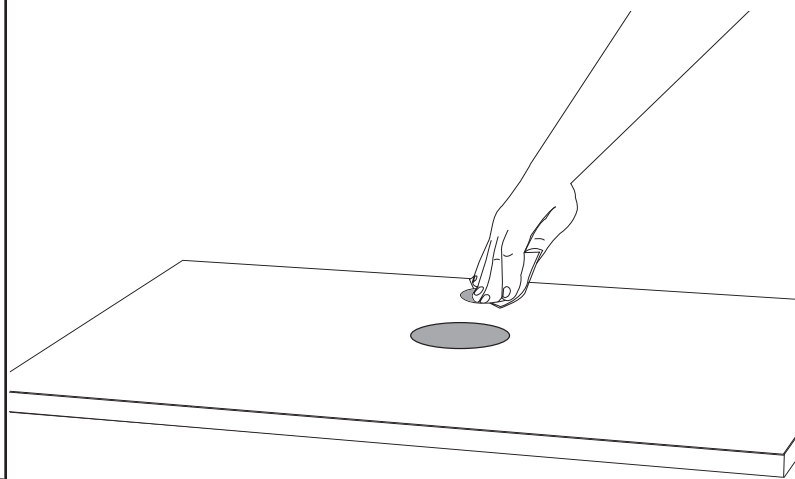

- 5** **Cherry Pie**
Sand the edges of the holes with 240 grit to remove any sharp edges.
Note: avoid sanding the top surface as this may cause scratching.
HPL Top
We recommend sealing raw edges with silicon.

FIXING & SEALING TOPS

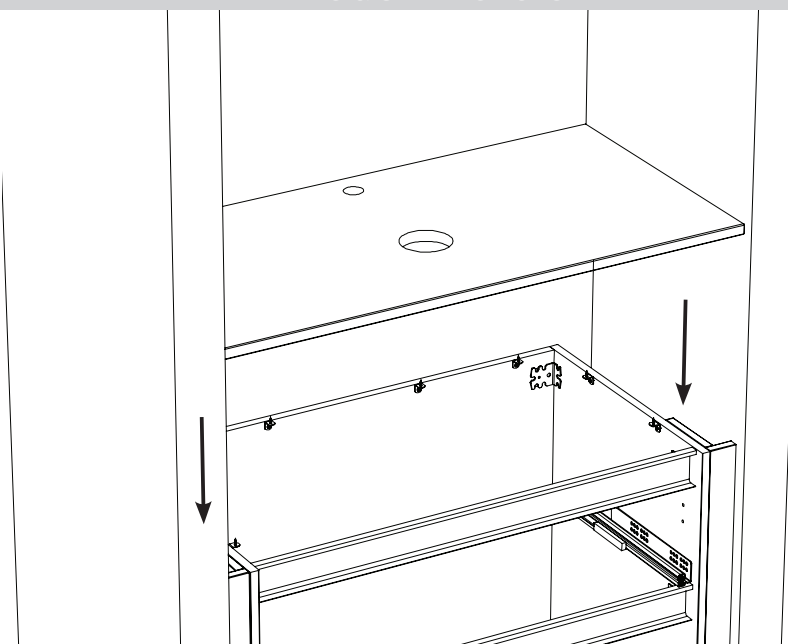

- 6** Fix top back into place using fixings if required & silicon to help water proof part lines.
Refer to Warranty, Installation & Care Guide pg14 for basin installation and water sealing instructions.

FIXING & SEALING TOPS

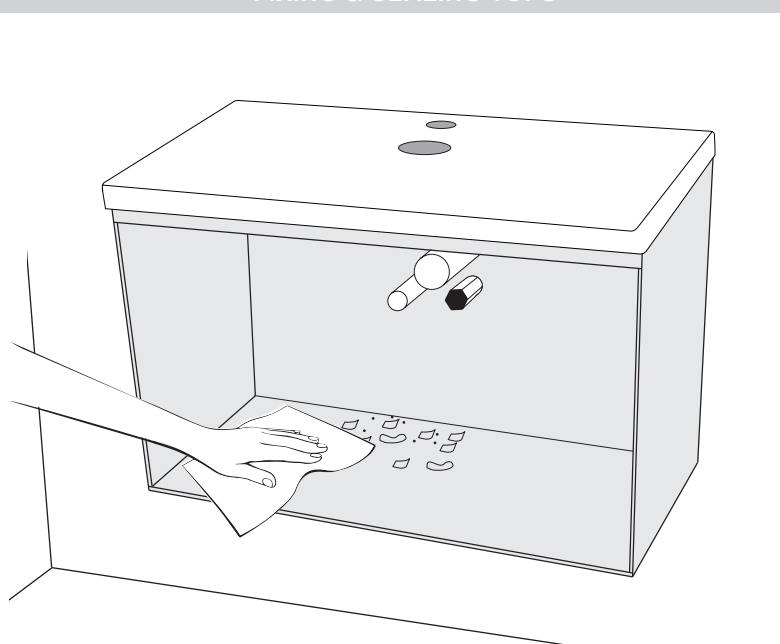

- 7** Clean away all building residue from the cabinet.
Take care to dry any spillage or leakage of water on or inside the cabinet during installation.
Note: Ensure drawer runners are free of building residue as this may effect the operation.

For next steps refer to Warranty, Installation & Care Guide supplied with your product or at stmichel.co.nz